



**SILICON  
DESIGNS  
INC.**

ECCN 7A994

**MODEL 1525 HIGH-END INDUSTRIAL/INERTIAL  
MEMS SURFACE MOUNT ACCELEROMETER**

- Excellent In-Run Bias Stability
- Zero Cross Coupling by Design
- Allan Variance from 5  $\mu$ g
- -40 to +85°C Operation
- $\pm$ 4V Differential Output
- +5 VDC, 5 mA Power (Typical)
- Internal Temperature Sensor
- Nitrogen Damped
- Hermetically Sealed
- Serialized for Traceability
- 9 mm sq. J-Lead LCC-20 Package

**STANDARD G-RANGES**

FULL SCALE ACCELERATION	20 PIN JLCC
$\pm$ 5 g	1525J-005
$\pm$ 10 g	1525J-010
$\pm$ 25 g	1525J-025
$\pm$ 50 g	1525J-050

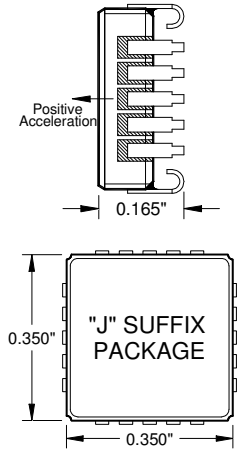
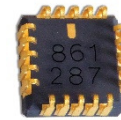
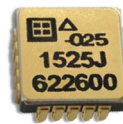

**DESCRIPTION**

The Model 1525 is the best in class, low-cost, integrated accelerometer for use in high-end industrial, inertial, and zero to medium frequency instrumentation applications requiring high repeatability and low noise. Each miniature, hermetically sealed package combines a MEMS capacitive sense element and a custom integrated circuit that includes a sense amplifier and differential output stage. It is relatively insensitive to temperature changes and gradients. Each device is marked with a serial number on its top and bottom surfaces for traceability. A calibration test report is supplied with each unit showing the measured bias, scale factor, linearity, operating current, & frequency response.

**ZERO (DC) TO MEDIUM FREQUENCY APPLICATIONS**



**PERFORMANCE\***

Unless otherwise specified  $V_{DD}=V_R=5.0$  VDC,  $T_C=25^\circ\text{C}$ , Differential Output, J-lead package

PERFORMANCE	INPUT RANGE:	$\pm$ 5G Typ (Max)	$\pm$ 10G Typ (Max)	$\pm$ 25G Typ (Max)	$\pm$ 50G Typ (Max)
In Run Bias Stability (Allan Variance Min) ( $\mu$ g)		10	20	50	100
Bias Calibration Error, Typical (mg) <sup>1</sup>		<50	<50	<125	<250
Long Term Bias Repeatability (mg (1 $\sigma$ )) <sup>4</sup>		1.5	1.5	3.75	7.5
Bias Temperature Coefficient (mg/ $^\circ\text{C}$ (max)) <sup>1</sup>		0.5	0.5	1.25	2.5
Long Term Scale Factor Repeatability (PPM (1 $\sigma$ )) <sup>4</sup>		400	400	400	400
Scale Factor Temperature Coefficient (PPM/ $^\circ\text{C}$ ) <sup>1</sup>		50	50	50	50
Long Term Scale Factor Stability (% of scale) <sup>4</sup>		0.03	0.03	0.03	0.03
Input Axis Misalignment (mrad (1 $\sigma$ ))		6	6	6	6
Vibration Rectification, 100 Hz ( $\mu$ g/g <sup>2</sup> rms)		100	100	75	75
Output Noise, Differential, Typical ( $\mu$ g/ $\sqrt{\text{Hz}}$ rms)		10	18	25	50
Velocity Random Walk (m/s/ $\sqrt{\text{Hr}}$ )		0.005	0.007	0.012	0.025
Temperature Sensor Sensitivity ( $\mu\text{A}/^\circ\text{C}$ ) (Nominal)		1.6	1.6	1.6	1.6

\*Specified -40° to +85°C

SPECIFICATIONS SUBJECT TO CHANGE WITHOUT NOTICE



# MODEL 1525 INERTIAL ACCELEROMETER

PERFORMANCE	INPUT RANGE:	±5G	±10G	±25G	±50G
		Typ (Max)	Typ (Max)	Typ (Max)	Typ (Max)
Frequency Response, Typical, 5% (Hz)		0 – 225	0 – 375	0 – 600	0 – 1200
Frequency Response, Typical, 3 dB (Hz)		0 – 400	0 – 600	0 – 900	0 – 1600
Frequency Response, Minimum, 3 dB (Hz)		0 – 300	0 – 420	0 – 660	0 – 1050
Sensitivity (Scale Factor), Differential (mV/g)		800	400	160	80

PARAMETER - All versions	MIN	TYP	MAX
RMS Model Residual (+/- 1g, -30° to +80°C) (PPM of FS)		100	200
Non-Linearity (% of FS) <sup>3</sup>		0.1	0.25
Bias Calibration Error, Typical (% Full Scale)			0.5
Scale Factor Calibration Error (% , Nominal)			0.5
Bias Temperature Coefficient (PPM Full Scale/C°)			50
Turn-On Transient (in less than 0.5 ms) (PPM of FS)		150	
Output Impedance (ohms)		90	
Operating Voltage (volts)	4.75	5.0	5.25
Operating Current (IDD+IVR) (mA)		5.5	6.5
Case Operating Temperature (°C) <sup>1</sup>	-55		+125
Storage Temperature (°C) <sup>1</sup>	-55		+125
Voltage on V <sub>DD</sub> to GND (Volts)	-0.5		6.0
Voltage on Any Pin (except DV) to GND (Volts) <sup>4</sup>	-0.5		V <sub>DD</sub> +0.5
Voltage on DV to GND (Self-Test) (Volts)		±15	
Mass, J-Lead Package (grams)		0.68	
Mechanical Shock (0.1 ms) (g - peak) By G-Range: ±2G and ±5G / ±10G, ±25G, and ±50G			2000 / 5000

- Output Span = ±4V differential output = 8000 mV
- Scale = measured value; FS = Full Scale = absolute output = 4000 mV

Note 1: (T<sub>c</sub>= -40° to +85°C) Tighter tolerances may be available on special order.

Note 2: Voltages on pins other than DV, GND or V<sub>DD</sub> may exceed 0.5 volt above or below the supply voltages provided the current is limited to 1 mA.

Note 3: Additional versions in 100g, 200g, and 400g are available by special order and are tested and specified from -65 to +65g.

Note 4: Tested as: Power cycle 100x, Shock 500g all axis, storage at -45°C and 85°C, temperature cycle 10x -40 to 120C, vibration 90%FS 125–1000Hz band.

Note 5: Measured from -30°C to +80°C

Note 6: Recommended Models:

- Applied Acceleration = Bias + BiasTC \* T + BiasTC2\*T\*\*2 + (5.00/VR)\*(SF+ SFTC\*T+ k2\*Vout)\*(Vout), where parameters are the least squares fit with T = (Measured Temp - 25C) and Vout = (Vaop-Vaon).
- The term (5.00/VR) can be ignored if calibrated in a production IMU with a repeatable reference or if the A/D reference and the VR voltage are derived from the same source.
- When the internal Temp Sensor is used, a recommended model is T = TBias + TSens\*Vit + TSens2 \* Vit\*\*2, where the temperature parameters are the least squares fit to (oven temperature-25C) and Vit is a voltage proportional to the current out of IT.

*\* NOTICE: Stresses greater than those listed above may cause permanent damage to the device. These are maximum stress ratings only. Functional operation of the device at or above these conditions is not implied. Exposure to absolute maximum rating conditions for extended periods may affect device reliability and lifespan.*

SPECIFICATIONS SUBJECT TO CHANGE WITHOUT NOTICE

## OPERATION

The model 1525 sensitive axis is perpendicular to the bottom of the package, with positive acceleration resulting from a positive force pushing on the bottom of the package. The seismic center is located on a centerline through the dual sense elements and halfway between them.

The Model 1525 produces a differential +/-4 volts output voltage, the value of which varies with acceleration as shown in figure 1. The seismic center is located on a centerline through the dual sense elements halfway between them. Any errors due to rotation about this point are effectively cancelled by the internal electronics.

Two reference voltages, +5.0 and +2.5 volts (nominal), are required; scale factor is ratiometric to the +5.0 volt reference voltage relative to GND, and both outputs at zero acceleration are nominally the same as the +2.5 volt input.

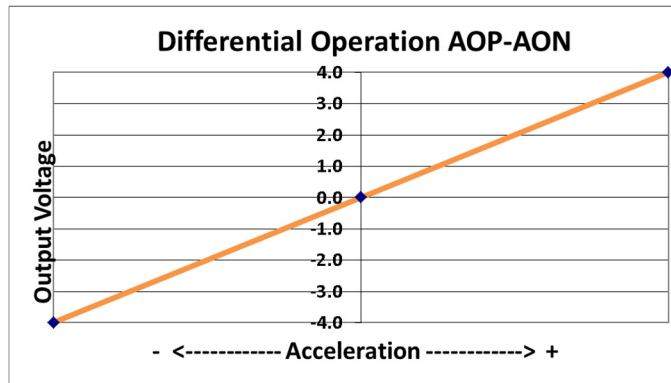

*The 1525 should not be used in  
Single Ended mode*

## SIGNAL DESCRIPTIONS

**V<sub>DD</sub> and GND (power):** Pins (14) and (19) respectively. Power (+5 Volts DC) and ground.

**AOP and AON (output):** Pins 12 and 16 respectively. Analog output voltages proportional to acceleration. The AOP voltage increases (AON decreases) with positive acceleration; at zero acceleration both outputs are nominally equal to the +2.5 volt reference. The device experiences positive (+1g) acceleration with its lid facing up in the earth's gravitational field. Use of differential mode is strongly recommended for both lowest noise and highest accuracy operation. Voltages can be measured ratio-metrically to VR for good repeatability without requiring a separate precision reference voltage for an A/D.

**DV (input):** Pin 4. Deflection Voltage. Connect to the 2.5 Volt pin for best repeatability. A test input that applies an electrostatic force to the sense element, simulating a positive acceleration. The nominal voltage at this pin is  $\frac{1}{2} V_{DD}$ . DV voltages higher than required to bring the output to positive full scale may cause device damage to 2g, 5g, and 10g devices.

**VR (input):** Pin 3. Voltage Reference. Tie to a good reference (not directly to V<sub>DD</sub>) for best scale factor repeatability. A 0.1μF bypass capacitor is recommended at this pin. The current is less than 100 μA.

**2.5 Volt (input):** Pin 17. Sets internal and output common mode value. Tie to a resistive voltage divider from +5 volts. A 0.1μF bypass capacitor is recommended at this pin. The current is less than 50 μA.

**I<sub>T</sub> (output)/ClkIn (Input):** Pin 8. Temperature dependent current source or optional external clock input. Tie to V<sub>DD</sub> if not used. See application note for details on ClkIn.

**Special Use Pins:** Pins 9 and 11 should be tied to V<sub>DD</sub>; Pins 2,5,6 and 18 to GND; Pins 1,7,10,13,15, and 20 are reserved and should remain unused. See application notes for possible special use of these pins.

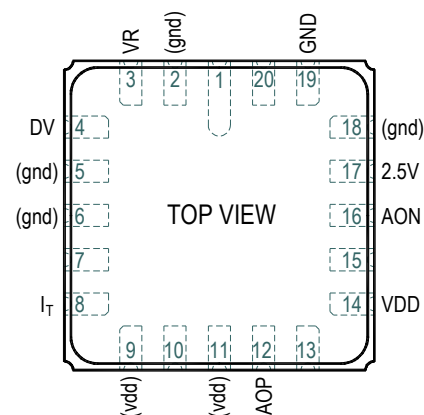

## RECOMMENDED CONNECTIONS

**DEFLECTION VOLTAGE (DV) TEST INPUT:** This test input applies an electrostatic force to the sense element, simulating a positive acceleration of up to +10g. It has a nominal input impedance of 32 kΩ and a nominal open circuit voltage of  $\frac{1}{2} V_{DD}$ . For best accuracy during normal operation, this input should be left unconnected or connected to a voltage source equal to  $\frac{1}{2}$  of the  $V_{DD}$  supply.

The change in differential output voltage (AOP - AON) is proportional to the square of the difference between the voltage applied to the DV input ( $V_{DV}$ ) and  $\frac{1}{2} V_{DD}$ . Only positive shifts in the output voltage may be generated by applying voltage to the DV input. When voltage is applied to the DV input on 2g, 5g, or 10g devices, it should be applied gradually to avoid damage. The application of DV voltages greater than required to bring the output to positive full scale may cause device damage. The proportionality constant ( $k$ ) varies for each device and is not characterized.

The 2.5V input (pin 17) may be driven from a resistive divider.

**ESD and LATCH-UP CONSIDERATIONS:** The model 1525 accelerometer is a CMOS device subject to damage from large electrostatic discharges. Diode protection is provided on the inputs and outputs, and it is not easily damaged, but care should be exercised during handling. However, individuals and tools should be grounded before coming in contact with the device. Although the 1525 is resistant to latch-up, inserting a 1525 into or removing it from a powered socket may cause damage.

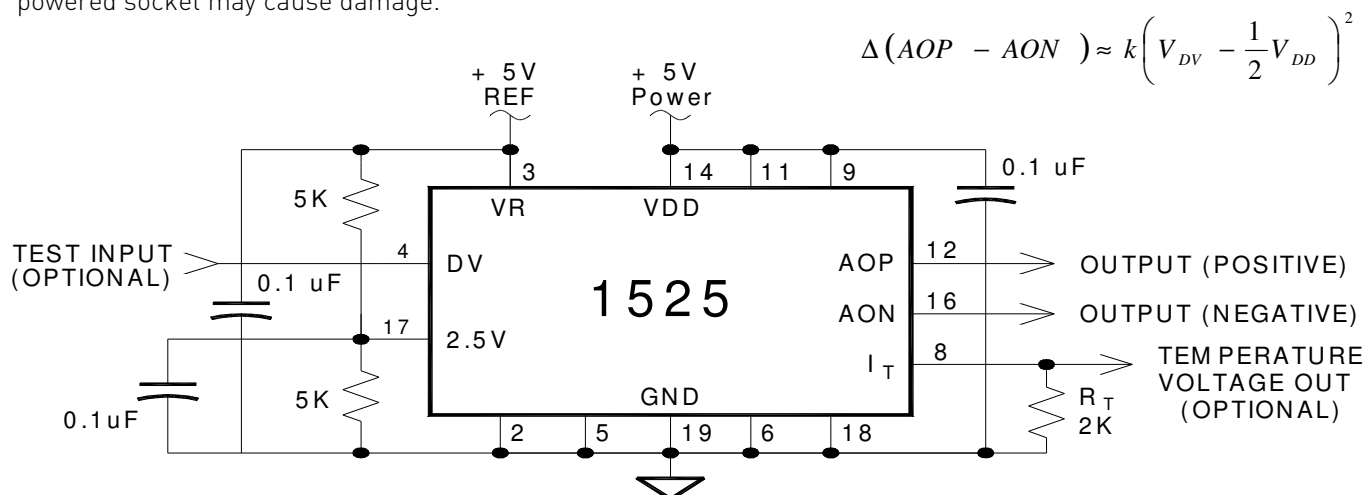

## INTERNAL CLOCK

The model 1525 contains an internal clock that runs at approximately 900 KHz. The internal clock is powered by  $V_{DD}$ . Like other synchronous sensors, it is subject to clock "lock-in" with other accelerometers driven by the same  $V_{DD}$ . To avoid possible lock-in and small bias jumps, it is recommended that the  $V_{DD}$  power to each accelerometer be supplied by separately buffered sources or filtered from a common well bypassed source by a LC filter with a minimum of 20 dB loss at 800 KHz. Alternatively, multiple accelerometers can be driven by the same external clock with a frequency in the range of 0.5 to 1 MHz. Contact SDI for more information on using an external clock.

**INTERNAL TEMPERATURE SENSING**

The model 1525 accelerometer outputs a temperature dependent current source on pin 8. This signal is useful for measuring the internal temperature of the accelerometer so that any previously characterized bias and scale factor temperature dependence, for a particular accelerometer, can be corrected. The nominal output current at 25°C is ≈500 (±200) μA and the nominal sensitivity is 1.5 (±0.5) μA/°C. With a single resistor  $R_T = 2K$  between  $I_T$  (pin 8) and GND the output voltage  $V_T$  will vary between +0.76 and +1.3 volts from -55 to +125°C, which equates to a sensitivity of ≈+3 mV/°C.

If a greater voltage change versus temperature or lower signal source impedance is needed, add the amplifier as shown on the right side in Figure 2. With offset voltage  $V_{OFF} = -5V$ , gain resistor  $R_G = 15.0K$  and offset resistor  $R_{OFF} = 7.32K$ , the output voltage  $V_T$  will vary between +4.5 and +0.5 Volts from -55 to +125°C, which equates to a sensitivity of ≈ -29 mV/°C. Figure 3 shows the voltage compliance of the temperature dependent current source ( $I_T$ ) at room temperature. The voltage at pin 8 must be kept in the 0 to +3V range in order to achieve proper temperature readings.

$$V_T \approx R_T [(500\mu A) + [(1.5\mu A)(T - 25)]]$$

$$\frac{\Delta V_T}{\Delta T} = R_T (1.5 \mu A)$$

$$R_{OFF} = \frac{-V_{OFF}}{\left(\frac{V_T}{R_G}\right) + (500\mu A) + [(1.5\mu A)(T - 25)]}$$

$$V_T \approx -R_G \left[ \frac{V_{OFF}}{R_{OFF}} + (500\mu A) + [(1.5\mu A)(T - 25)] \right]$$

$$\frac{\Delta V}{\Delta T} = -R_G (1.5\mu A) \quad R_G = \frac{-\Delta V_T}{(1.5\mu A)(\Delta T)}$$

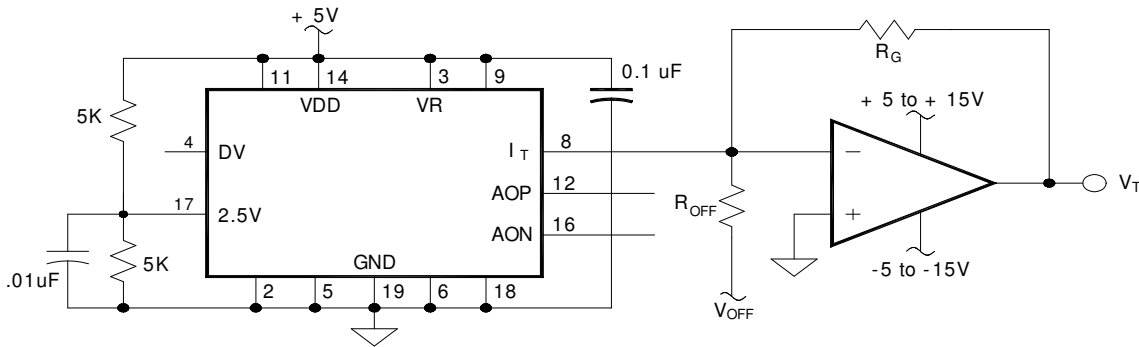
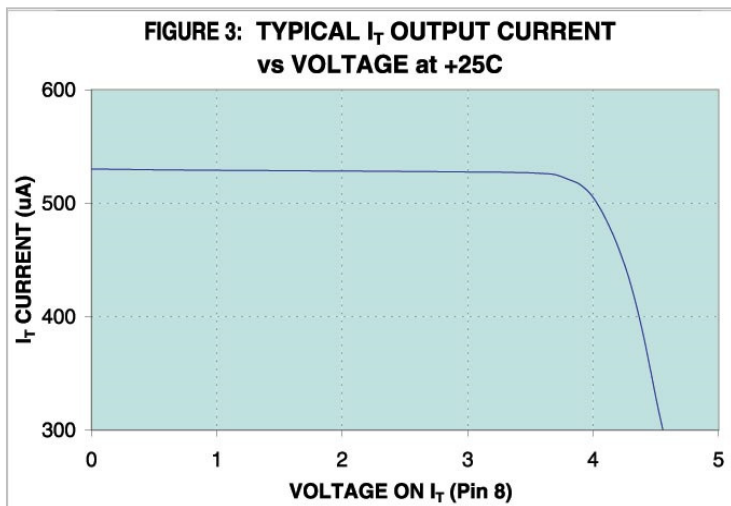

Figure 2



Temperature Sensor White Noise (1-1000 Hz):			
MIN	TYP	MAX	UNITS
0.25	0.25	0.25	°C rms

## PACKAGE DIMENSIONS

1. \*Dimensions "M," "T," and "U" locate sensing element's center of mass.
2. Lid is electrically tied to terminal 19 (GND).
3. Controlling dimension: Inch.
4. Terminals are plated with 60 micro inches min gold over 80 micro inches min nickel. This plating specification does not apply to the Pin-1 identifier mark on the bottom of the J-lead package version.
5. Package: 90% min alumina (black), lid: solder sealed kovar.

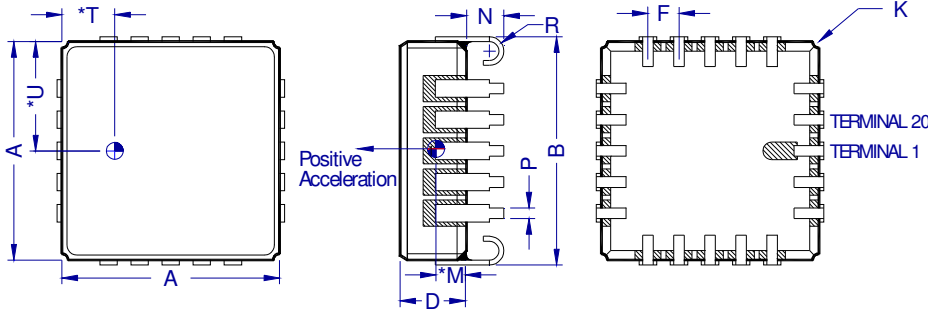

Dim	Inches		Millimeters	
	Min	Max	Min	Max
A	0.342	0.358	8.69	9.09
B	0.346	0.378	8.79	9.60
D	0.095	0.115	2.41	2.92
F	0.050 BSC		1.27 BSC	
K	0.010 R TYP		0.25 R TYP	
* M	0.066 TYP		1.68 TYP	
N	0.050	0.070	1.27	1.78
P	0.017 TYP		0.43 TYP	
R	0.023 R TYP		0.58 R TYP	
* T	0.085 TYP		2.16 TYP	
* U	0.175 TYP		4.45 TYP	

## SOLDERING RECOMMENDATIONS

**RoHS Compliance:** The model 1525 does not contain elemental lead and is RoHS compliant.

**Pre-Tinning of Accelerometer Leads is Recommended:** To prevent gold migration embrittlement of the solder joints, it is best to pre-tin the accelerometer leads.

**Soldering:** Solder reflow should not exceed 239°C, exceeding this temperature may result in permanent damage.

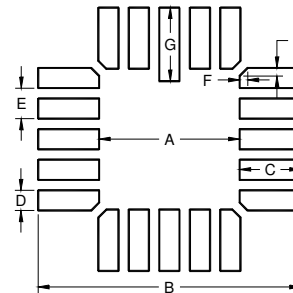

DIM	Inch	mm
A	.230	5.84
B	.430	10.92
C	.100	2.54
D	.033	0.84
E	.050	1.27
F	.013	0.33
G	.120	3.05

**J-LCC Solder Contact Plating Information:** The plating composition and thickness for the solder pads and castellations on the J-Lead package top layer is 100 to 225 micro inches thick of 99.7% gold (Au) over 80 to 350 micro inches thick of electroplated nickel (Ni).

The aforementioned dimensions are recommendations only and may or may not be optimal for your soldering process.

*Do not use ultrasonic cleaners. Ultrasonic cleaning voids the warranty and may break internal wire bonds.*

## COMPANION ACCESSORY

The Model EB-J Analog Test Sets provide a convenient means of testing and evaluating SDI Model 1525 surface mount accelerometers in the JLCC package format. The zero-insertion-force socket is pre-fitted to the board, which includes set jumpers for advanced features of SDI accelerometers. A 10-pin connector and ribbon cable provide connections to the user's test equipment. The EB-J Set and SDI Surface Mount Accelerometers are each sold separately.

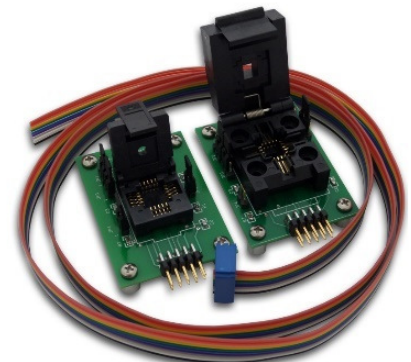

SPECIFICATIONS SUBJECT TO CHANGE WITHOUT NOTICE

**TEST REPORT EXAMPLES:  
LINEARITY, PHASE & FREQUENCY RESPONSE BY G-LEVEL**

The included 1525-TST test reports provide additional information about the linearity, output, phase, and frequency response as tested for each individual unit. The following are examples of the graphical data supplied on test reports, by G-level.

NOTE: Frequency response on test reports is documented by simulating frequency response with the DV pin. This will indicate lower values than the actual performance once soldered or otherwise permanently installed on a board.

**EXAMPLE 5G: 1525J-005**

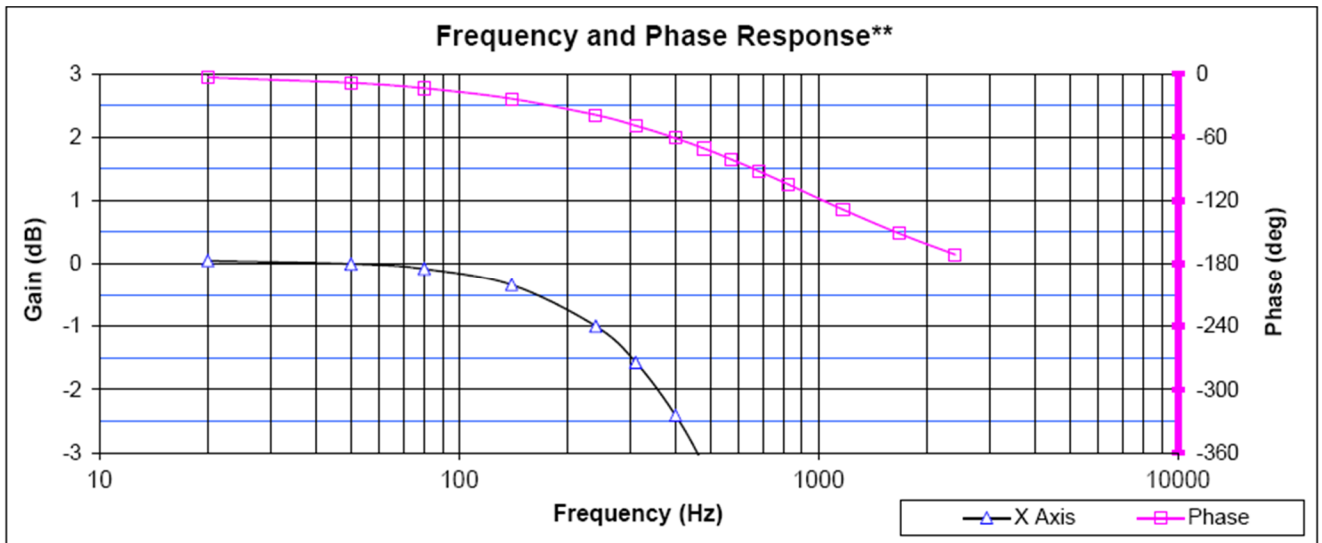
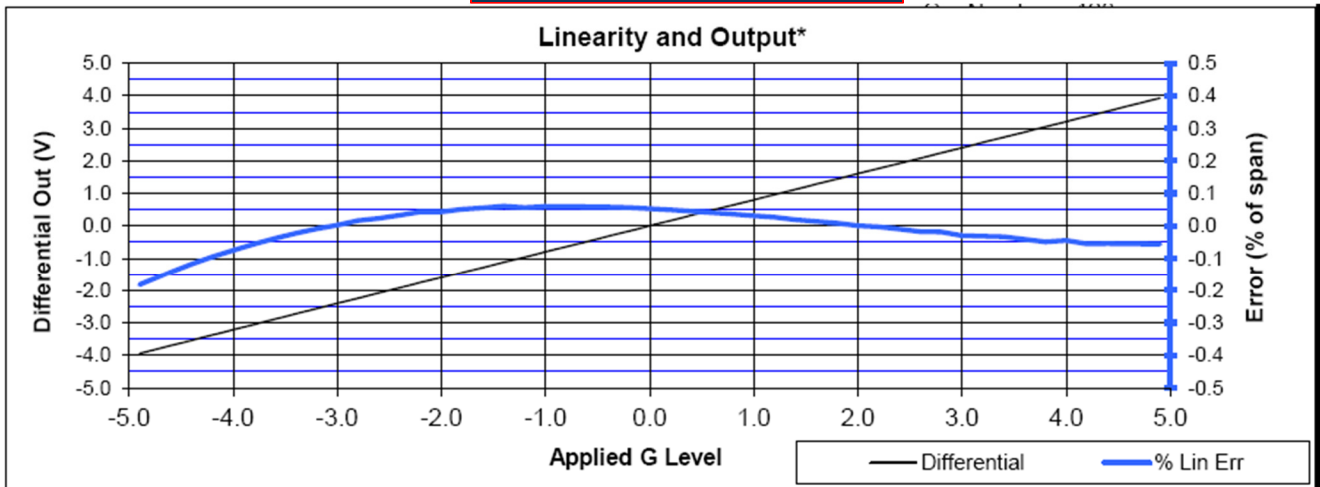

SPECIFICATIONS SUBJECT TO CHANGE WITHOUT NOTICE

**EXAMPLE 10G: 1525J-010**

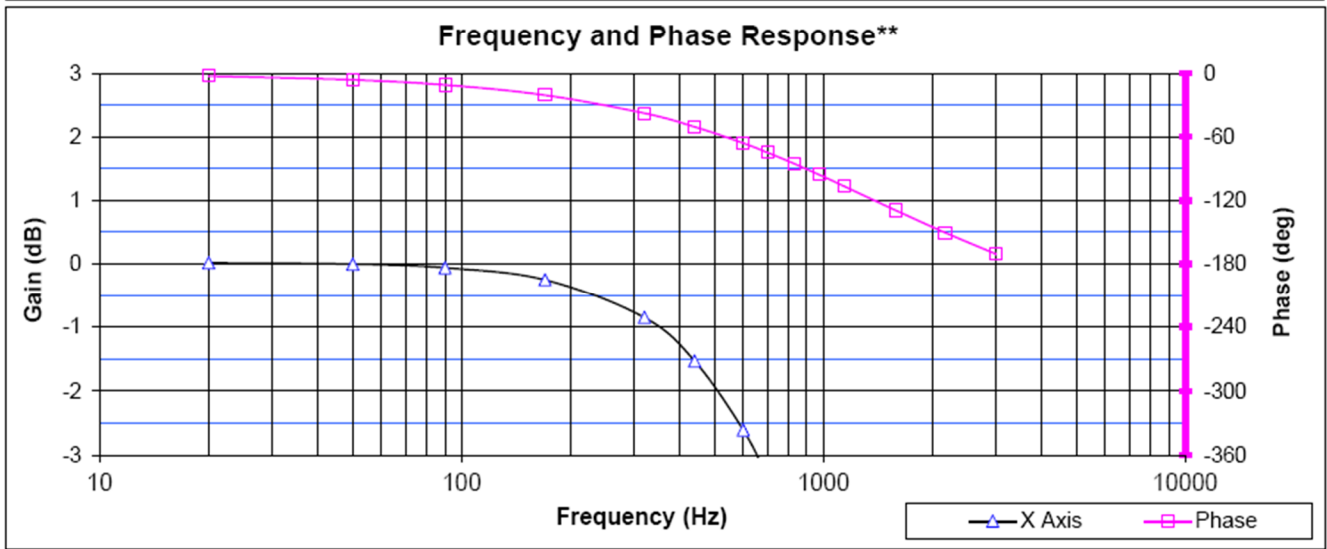
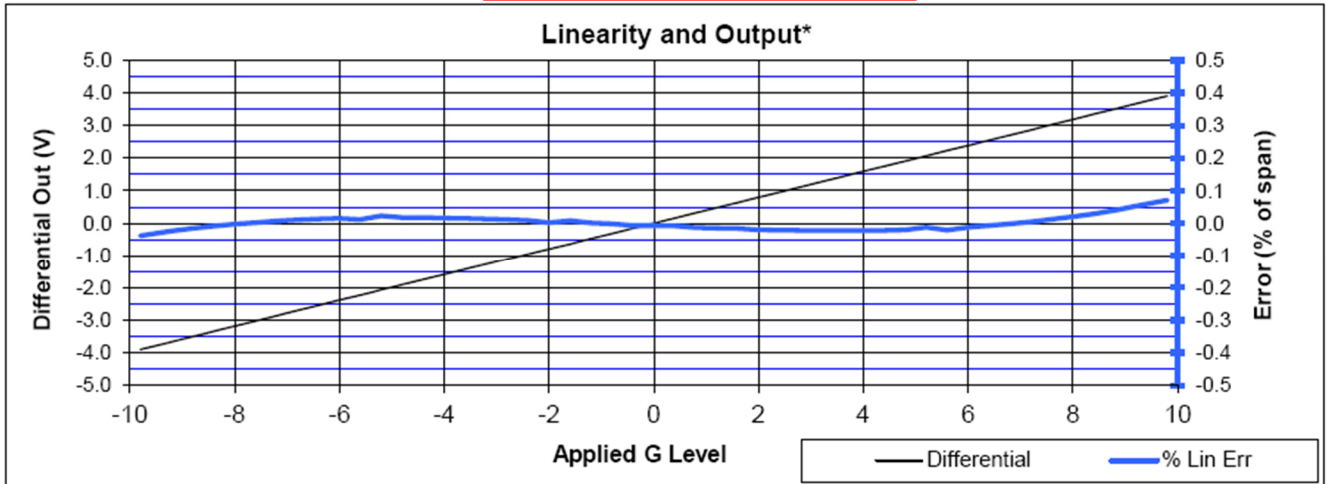

SPECIFICATIONS SUBJECT TO CHANGE WITHOUT NOTICE



**EXAMPLE 25G: 1525J-025**

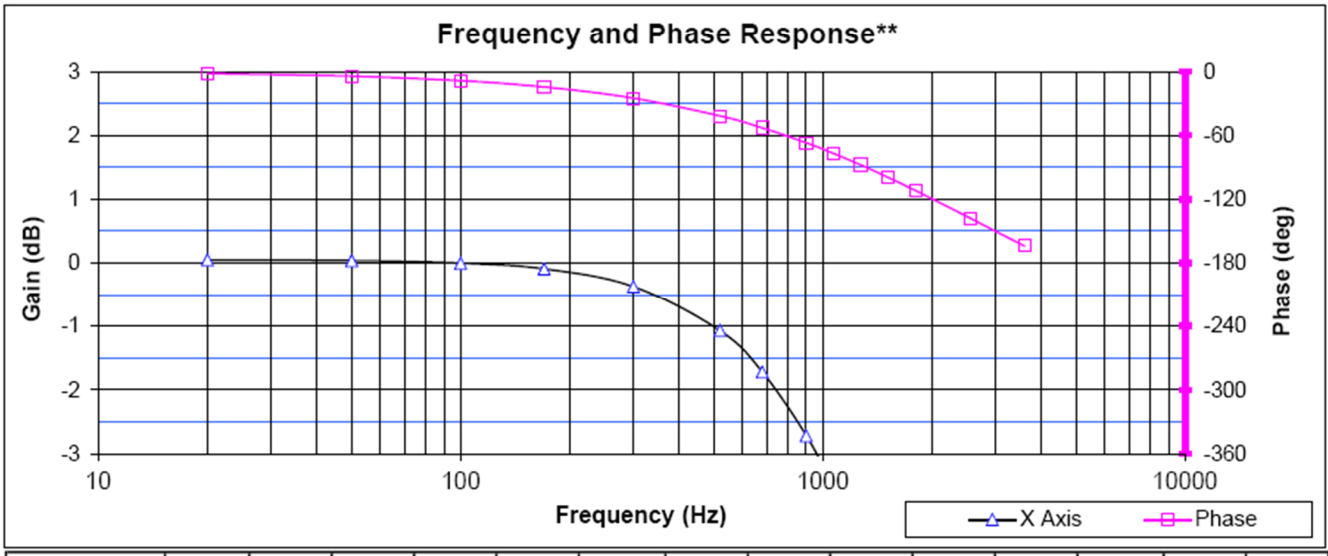
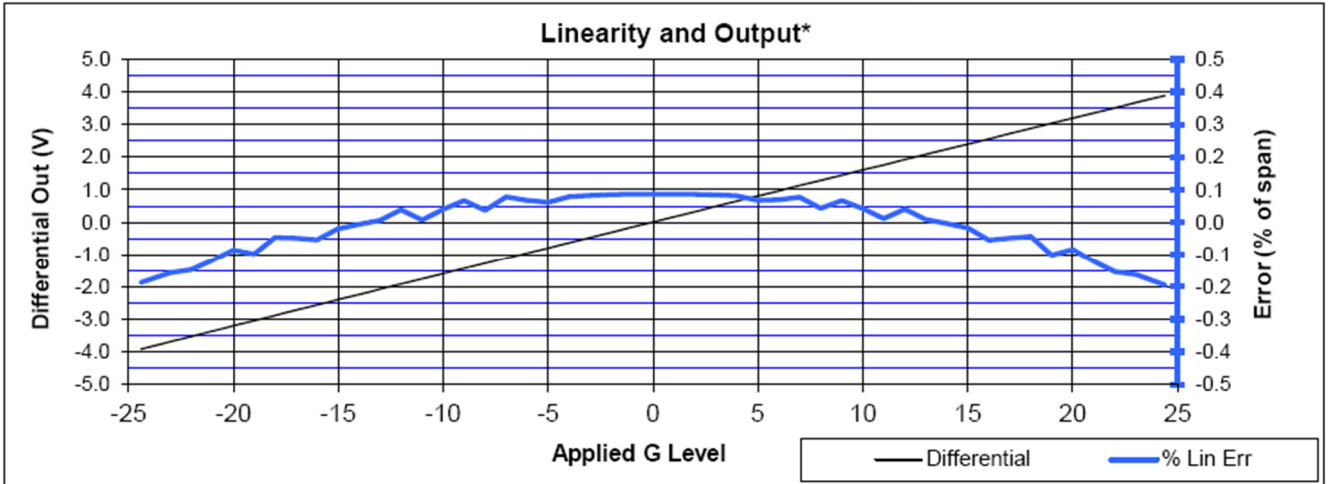

SPECIFICATIONS SUBJECT TO CHANGE WITHOUT NOTICE



**SDI**

MODEL 1525 INERTIAL ACCELEROMETER

EXAMPLE 50G: 1525J-050

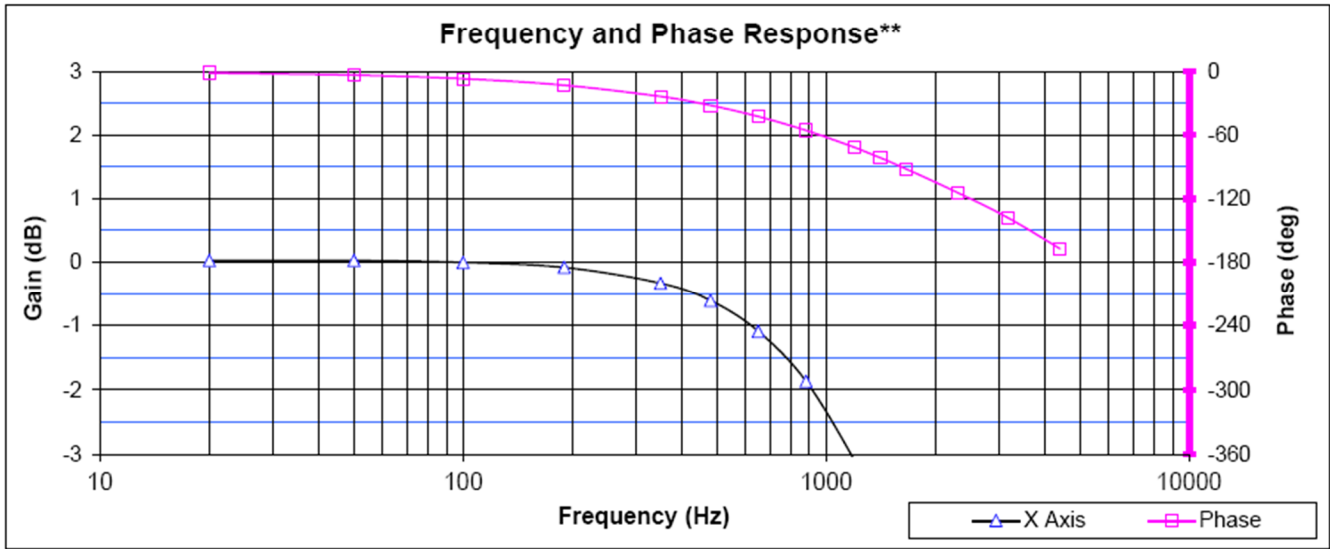
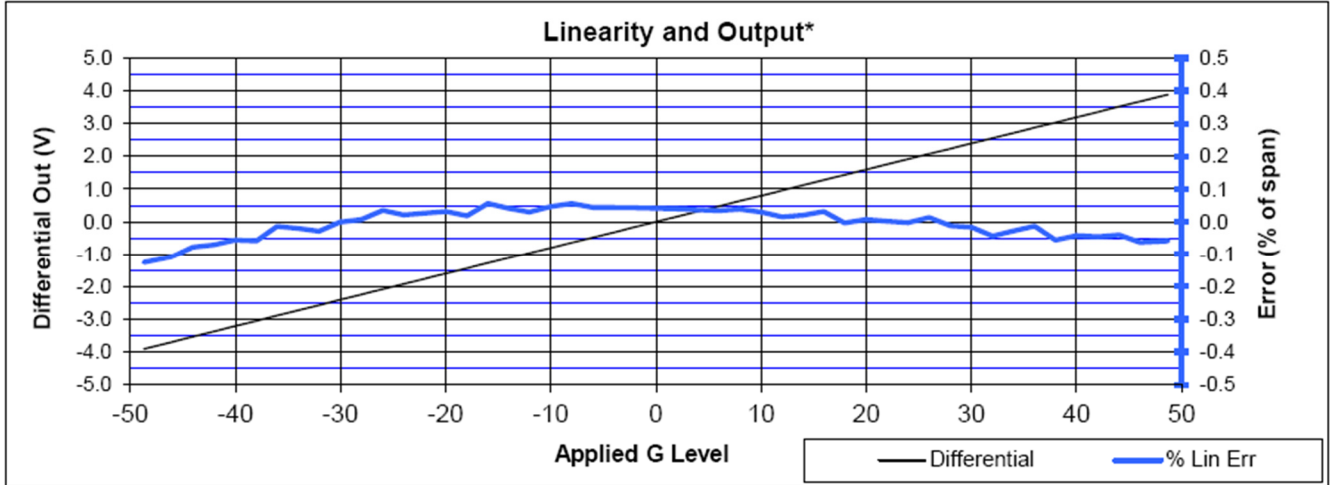

SPECIFICATIONS SUBJECT TO CHANGE WITHOUT NOTICE